

HYDRAULICS SLEWING

RASTRILLA HIDRÁULICA

- › La rastrilla hidráulica se puede montar mediante la conexión a la excavadora
- › La rotación hidráulica permite que el equipo gire sobre sí mismo en una rotación parcial de 320°

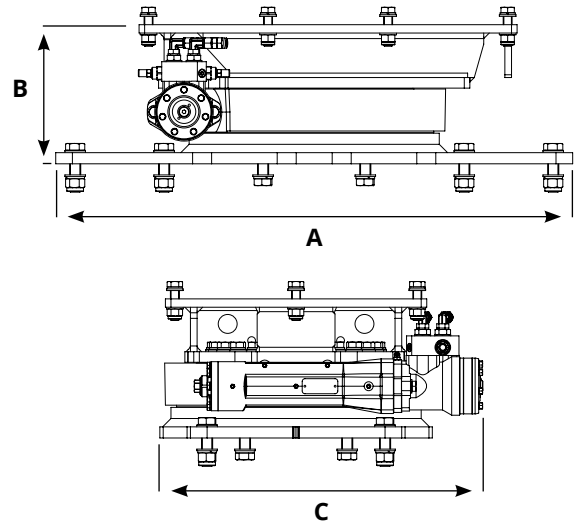

Model	A mm	B mm	C mm	Max Rotation	Kg.	Model. PLURY
HYDRAULICS SLEWING 7/16 ton	650	245	526	320°	170	W1 65.0 W1 95.0 W2 60.0 W2 80.0
HYDRAULICS SLEWING 12/25 ton	720	245	526	320°	175	W2 100.0 W2 120.0
HYDRAULICS SLEWING 18/40 ton	930	250	581	320°	260	W2 150.0 W2 180.0

